

6 5 4 3 2 1

ITEM 1  
PART No UNVPOST001  
RIGHT HAND GATE POST  
UNIVERSAL

ITEM 2  
PART No UNVPOST002  
LEFT HAND GATE POST  
UNIVERSAL

FIXINGS  
M10 x 40mm HEX HEAD BOLT x 34 OFF  
M10 WASHER x 34 OFF



ITEM 3  
RIGHT HAND GATE  
3m  
3.2m  
3.6m  
4m

ITEM 4  
LEFT HAND GATE  
3m  
3.2m  
3.6m  
4m

ITEM 5  
PART No BCRM001  
BOTTOM CROSSMEMBER

ITEM 6  
PART No HINGEPACK  
GATE HINGE ASSEMBLY

ITEM 7  
JUNC001  
60mm DIA JUNCTION BOX

ITEM 8  
PART No STPLATE  
STOP PLATE

ITEM 9  
TCRM001  
TOP TEMP CROSSMEMBER

Underground Gate Kit Parts List		
ITEM	QTY	DESCRIPTION
1	1	RIGHT HAND GATE POST
2	1	LEFT HAND GATE POST
3	1	RIGHT HAND GATE
4	1	LEFT HAND GATE
5	1	BOTTOM CROSSMEMBER
6	2	GATE HINGE ASSEMBLY
7	2	60mm JUNCTION BOX
8	1	STOP PLATE
9	1	TOP TEMP CROSSMEMBER
10	2	AUTOMATION (IF SELECTED)
11	1	AEROSOL CAN TOUCH-UP SPRAY PAINT
12	34	M10 x 40mm LONG HEX HEAD BOLT

**BERKSHIRE GATES LTD.**  
UNIT 5 A/B  
MEMBURY BUSINESS PARK  
LAMBOURN WOODLANDS  
HUNGERFORD  
BERKSHIRE RG17 7TJ

M 07770 933 861  
T 0800 88 18 498  
F 0800 88 18 598

DRAWING WORK BY  
bonnywell@cockipgogmail.com

Revisions

THIS DRAWING IS THE PROPERTY OF  
**BERKSHIRE GATES LTD.**  
COPYRIGHT IS RESERVED BY THEM AND THE DRAWING IS ISSUED  
ON THE CONDITION THAT IT IS NOT USED, COPIED, REPRODUCED  
RETAINED OR DISCLOSED EITHER WHOLLY OR IN PART, BY OR TO  
ANY UNAUTHORISED PERSONS WITHOUT THE PREVIOUS CONSENT  
IN WRITING OF BERKSHIRE GATES LTD.

WRITTEN DIMENSIONS ON THIS DRAWING SHALL HAVE  
PRECEDENCE OVER SCALED DIMENSIONS.

Client **BERKSHIRE GATES**

Title **UNDERGROUND GATE KIT  
PARTS LIST & ASSEMBLY DETAILS**

Drawing Number **WINUGINS 0001** Rev **A3** Sheet Size **A3**

Sheet **SHEET 1 of 3** Scale **-**

Drawn **BJW** Date **19/12/2010**

Checked **-** Date **-**

6 5 4 3 2 1

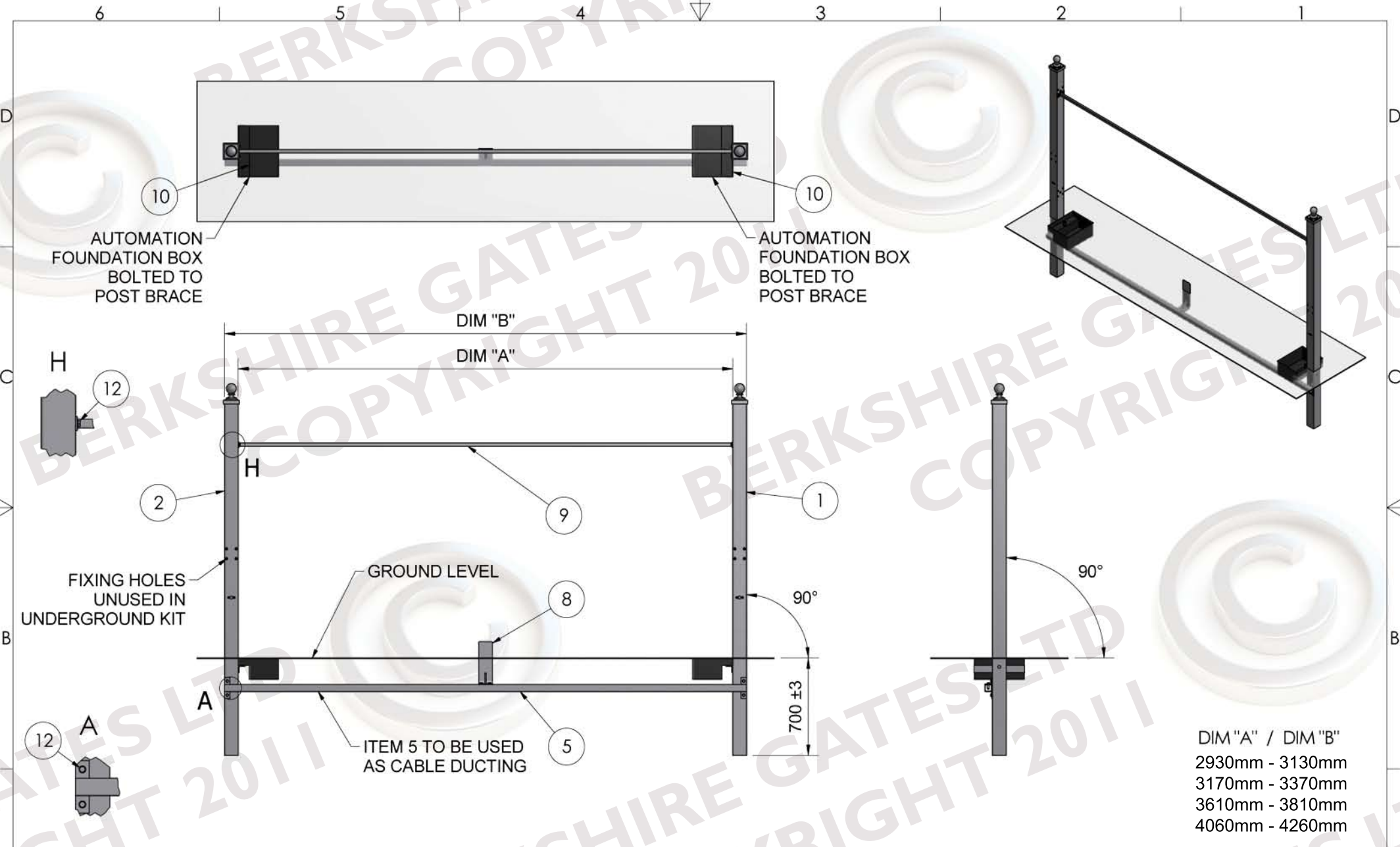

10  
AUTOMATION  
FOUNDATION BOX  
BOLTED TO  
POST BRACE

10  
AUTOMATION  
FOUNDATION BOX  
BOLTED TO  
POST BRACE

DIM "B"

DIM "A"

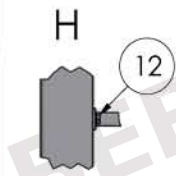

12  
FIXING HOLES  
UNUSED IN  
UNDERGROUND KIT

GROUND LEVEL

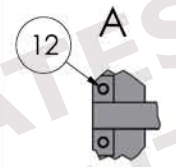

ITEM 5 TO BE USED  
AS CABLE DUCTING

90°

700 ±3

DIM "A" / DIM "B"  
2930mm - 3130mm  
3170mm - 3370mm  
3610mm - 3810mm  
4060mm - 4260mm

**BERKSHIRE GATES LTD.**  
UNIT 5 A/B  
MEMBURY BUSINESS PARK  
LAMBOURN WOODLANDS  
HUNGERFORD  
BERKSHIRE RG17 7TJ  
M 07770 933 861  
T 0800 88 18 498  
F 0800 88 18 598  
DRAWING WORK BY  
boanym@cockitgogmail.com

THIS DRAWING IS THE PROPERTY OF  
**BERKSHIRE GATES LTD.**  
COPYRIGHT IS RESERVED BY THEM AND THE DRAWING IS ISSUED  
ON THE CONDITION THAT IT IS NOT USED, COPIED, REPRODUCED  
RETAINED OR DISCLOSED EITHER WHOLLY OR IN PART, BY OR TO  
ANY UNAUTHORISED PERSONS WITHOUT THE PREVIOUS CONSENT  
IN WRITING OF BERKSHIRE GATES LTD.  
WRITTEN DIMENSIONS ON THIS DRAWING SHALL HAVE  
PRECEDENCE OVER SCALED DIMENSIONS.

Client	BERKSHIRE GATES
Title	UNDERGROUND GATE KIT PARTS LIST & ASSEMBLY DETAILS

Drawing Number	WINUGINS 0001	Rev	A3	
Sheet	SHEET 2 of 3		Scale	-
Drawn	BJW	Date	19/12/2010	
Checked	-	Date	-	

BERKSHIRE GATES LTD  
COPYRIGHT 2011

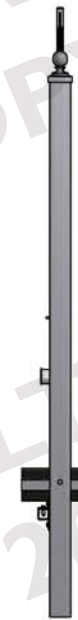
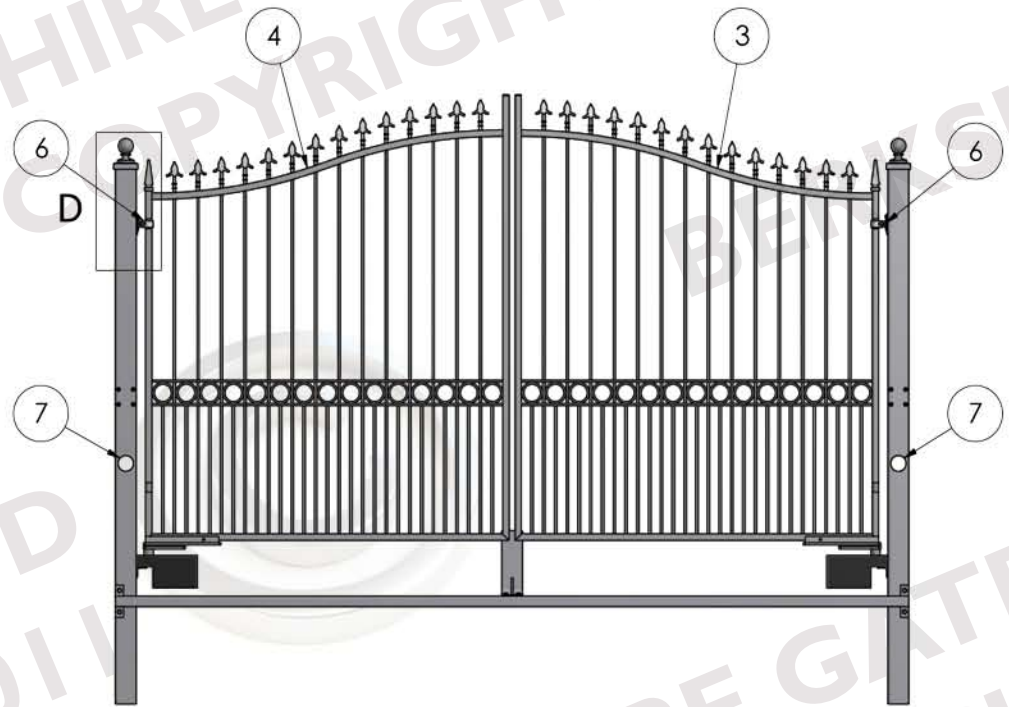
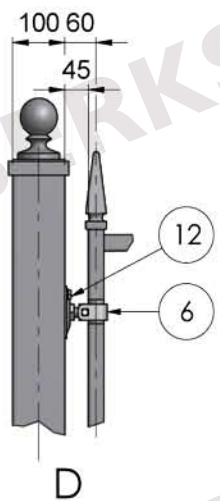
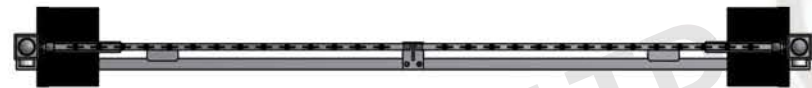

**BERKSHIRE GATES LTD.**  
 UNIT 5 A/B  
 MEMBURY BUSINESS PARK  
 LAMBOURN WOODLANDS  
 HUNGERFORD  
 BERKSHIRE RG17 7TJ  
 M 07770 933 861  
 T 0800 88 18 498  
 F 0800 88 18 598  
 DRAWING WORK BY  
 boanymw@cockitgogmail.com

THIS DRAWING IS THE PROPERTY OF  
**BERKSHIRE GATES LTD.**  
 COPYRIGHT IS RESERVED BY THEM AND THE DRAWING IS ISSUED  
 ON THE CONDITION THAT IT IS NOT USED, COPIED, REPRODUCED  
 RETAINED OR DISCLOSED EITHER WHOLLY OR IN PART, BY OR TO  
 ANY UNAUTHORISED PERSONS WITHOUT THE PREVIOUS CONSENT  
 IN WRITING OF BERKSHIRE GATES LTD.  
 WRITTEN DIMENSIONS ON THIS DRAWING SHALL HAVE  
 PRECEDENCE OVER SCALED DIMENSIONS.

Client	BERKSHIRE GATES
Title	UNDERGROUND GATE KIT PARTS LIST & ASSEMBLY DETAILS

Drawing Number	WINUGINS 0001	Rev	Sheet Size
Sheet	SHEET 3 of 3	Scale	A3
Drawn	BJW	Date	19/12/2010
Checked	-	Date	-